

产品BOM表

NO.	产品名称	产品编码	数量	材质/表面处理
①	COB1919前盖-PBT白	92.70.524.00-Q1	1	PBT+15%GF/素材白
②	COB1919后盖-PBT白	92.70.524.00-H2	1	
③	COB免焊支架端子		2	t=0.25mm铜镀镍+加硬

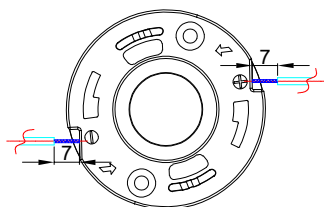
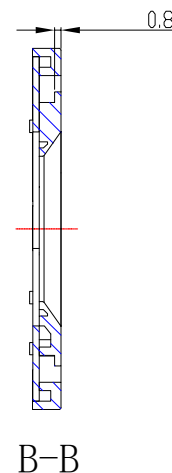
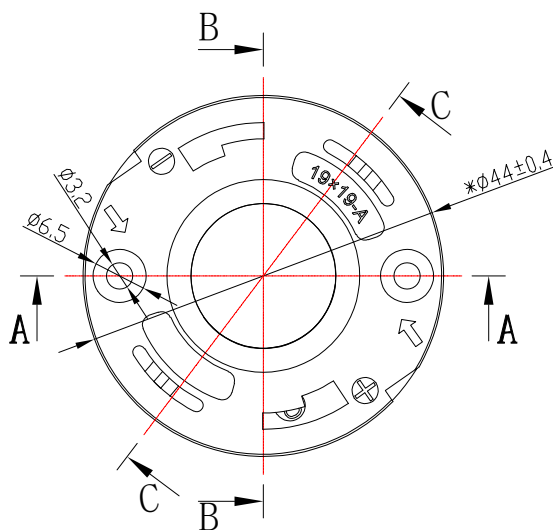
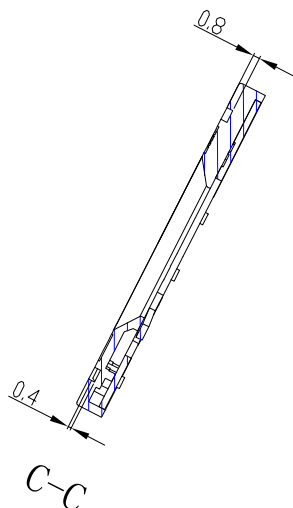
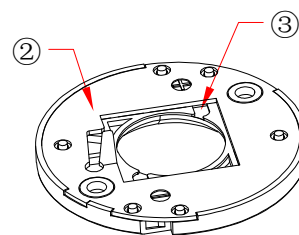
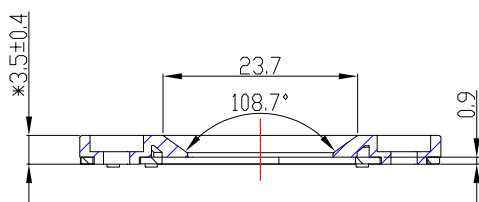
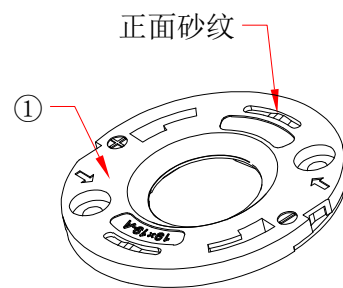
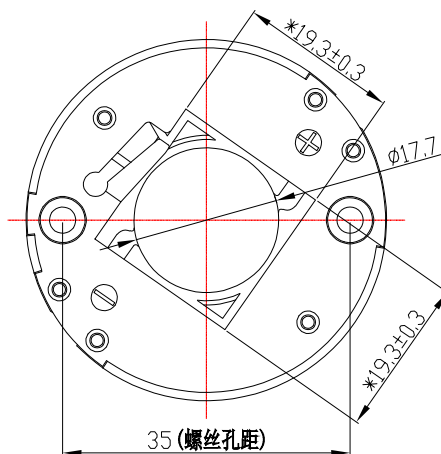

Wire specifications:  
0.32 mm<sup>2</sup> to 0.81 mm<sup>2</sup>.  
18AWG, 20AWG, 22AWG.  
Strip length: 7 mm. Surface tin-plated.

电线规格:  
0.32毫米<sup>2</sup>至0.81毫米<sup>2</sup>.  
18AWG, 20AWG, 22AWG.  
剥线长度7毫米, 表面镀锡。

技术要求:

- 1.材质: 详见bom表。  
Material: Refer to the BOM table.
2. "\*" 标记为重点控制尺寸。  
The "\*" marked items are the key controlled dimensions.
- 3.未注公差按GB/T14486-2008-MT6。  
The unmarked tolerances follow GB/T14486-2008-MT6.
- 4.适配: V13, CLU 03X等基板规格为19×19的COB光源。  
Compatibility: V13, CLU 03X and other substrate specifications with a size of 19×19 for COB light source

				<b>Nata</b> <sup>®</sup>		版本 VERSIONS	
						K0-PL	
				产品编码 PRODUCT CODE		92.70.524.00	
				产品名称 PRODUCT NAME		COB1919-A-L14.5光源免焊 支架-PBT白 φ44H3.5	
				客户 CUSTOMER		NT	
标记 MARK	处数 NO. OF MODIF.	更改内容 MODIFICATIONS		签名 SIGNED BY	更改日期 MODIF. DATE		
设计 DESIGNER		制图 DRAWN BY		比例 SCALE	1:1		
工艺 TECHNICIAN		审核 CHECKED BY		视角 1ST ANGLE PROJECTION			
批准 APPROVED BY		日期 DATE(DD-MM-YYYY)	05-11-2025	页数 PAGE	SHEET 1 OF 1		
产品图 PRODUCT DRAWING						单位 UNIT	客户产品编号 CUSTOMER PRODUCT CODE
						mm	COB1919-A-L14.5-PK45 HOLDER-PBT白